

HE2G Compact Grip Enabling Switch

Key features:

- New compact, light-weight grip switch provides a comfortable hold
- Compact design fits comfortably in the hand
- Light operating force ensures worry-free operation
- 3-position switch with distinctive tactile feedback
- Dual enabling contacts ensure a high level of safety

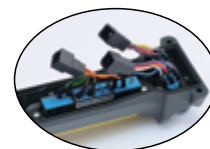
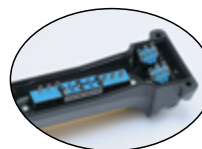
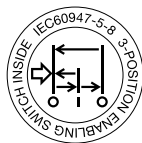

Part Numbers

Additional Control Units		Rubber Boot Color	Solder Terminal	Internal Connector
None		Yellow	HE2G-21SH	HE2G-21SC
		Gray	HE2G-21SH-1N	HE2G-21SC-1N
Estop		Yellow	HE2G-21SHE	
Estop and Green Pilot Light			HE2G-21SHE-P-0	
Two Momentary Pushbuttons			HE2G-21SH-L-L	
E-Stop and Two Momentary Pushbuttons		HE2G-21SHE-L-L	HE2G-21SCE-L-L	
E-Stop, Momentary Pushbutton and Key Switch		HE2G-21SHE-L-K	HE2G-21SCE-L-K	



1. Additional control units installed on the HE2G are as follows:
 Emergency Stop Switch: XA1E-BV3U02R
 Momentary Pushbutton: AB6M-M2PLW
 Key Selector Switch: AS6M-2KT2PA Pilot Light: UP9P-2498G

2. Silicon rubber: Can be used in general factories. Remains flexible in cold temperatures. Suitable in applications with a wide operating temperature range.
 3. NBR/PVC polyblend: Oil-proof. Suitable for environments subjected to machine oil and painting robots where silicon rubber cannot be used.

Overview

XW Series E-Stops

Interlock Switches

Enabling Switches

Safety Control Relays

Light Curtains

AS-Interface Safety at Work

Specifications

Overview	Applicable Standards	UL508 (UL recognition) CSA C22.2, No. 14 (c-UL recognition) IEC/EN 60947-5-1 (TÜV) GS-ET-22 (TÜV approval)
	Applicable Standards for Use	ISO 12100-1, -2 IEC 60204-1/EN 60204-1 ISO11161 / prEN11161 ISO 10218 / EN 775 ANSI/RIA R15.06 ANSI B11.19
XW Series E-Stops	Operating Temperature	Silicon rubber boot: -25 to 60°C (no freezing) NBR/PVC Polyblend rubber boot: -10 to 60°C (no freezing)
	Relative Humidity	45 to 85% (no condensation)
	Storage Temperature	-40 to +80°C (no freezing)
	Pollution Degree	3
Interlock Switches	Contact Resistance	50 mΩ maximum (initial value)
	Insulation Resistance	Between live and dead metal parts: 100 MΩ minimum (500V DC megger) Between terminals of different pole: 100 MΩ minimum (500V DC megger)
	Impulse Withstand Voltage	(Solder terminal) Grip style enabling switch/emergency stop switch: 2.5 kV Momentary pushbutton/key selector switch: 1.5 kV Pilot light: 500V AC, 1 minute (between live and dead parts) (Internal connector) Grip style enabling switch/emergency stop switch/momentary pushbutton/key selector switch: 1.5 kV
Enabling Switches	Electric Shock Protection Class	Class II (IEC 61140) (With pilot light: class III)
	Operating Frequency	1,200 operations per hour
	Mechanical Life	Position 1 → 2 → 1: 1,000,000 operations minimum Position 1 → 2 → 3 → 1: 100,000 operations minimum
	Electrical Life	100,000 operations minimum (rated load) 1,000,000 operations minimum (24V AC/DC, 100 mA)
	Shock Resistance	Operating extremes: 150 m/s ² (15G) Damage limits: 1,000 m/s ² (100G)
	Vibration Resistance	Operating extremes: 5 to 55 Hz, amplitude 0.5 mm minimum Damage limits: 16.7 Hz, amplitude 1.5 mm minimum
Safety Control Relays	Applicable Wire	Solder terminal: 0.5 mm ² maximum (20 AWG) Internal connector: 0.05 to 0.86 mm ² (AWG18 to 30)
	Applicable Wire Size	Solder terminal: 0.5 mm ² (20 AWG) Internal connector: 0.05 to 0.86 mm ² (AWG18 to 30) (AWG22 between switch and connector)
	Applicable Cable	Outside diameter: ø4.5 to 10 mm
	Conduit Port Size	M16 (cable gland is supplied)
Light Curtains	Terminal Tensile Strength	20N minimum
	Degree of Protection	With control unit: IP67/IP66 (IEC 60529) Without control unit: IP65 (IEC 60529)
	Conditional Short-circuit Current	50A (250V) (Use 250V/10A fast-blow fuse for short circuit protection.)
	Direct Opening Force	60N minimum (monitor switch)
	Operator Strength	500N minimum (when pressing the entire button surface)
AS-Interface Safety at Work	Weight (approx.)	HE2G-21SH: 140g HE2G-21SH-P-0/-21SC: 145g HE2G-21SHE/-21SC-P-0: 150g HE2G-21SH-L-L/-21SHE-P-0/-21SCE: 155g HE2G-21SH-L-K/-21SCE-P-0: 160g HE2G-21SHE-L-L/-21SC-L-L: 165g HE2G-21SHE-L-K/-21SC-L-K: 170g HE2G-21SCE-L-L: 175g HE2G-21SCE-L-K: 180g

Contact Ratings

Rated Insulation Voltage (Ui)				250V (momentary pushbutton and key selector: 125V) / 30V (with pilot light)			
Rated Thermal Current (Ith)				3A (emergency stop switch: 5A)			
Rated Voltage (Ue)				30V	125V	250V	
Rated Current	Grip Style Enabling Switch	3-position switch (Terminal No. N01-C1/A1-B1, N02-C2/A3-B3)	AC	Resistive Load (AC-12)	—	1A	0.5A
				Inductive Load (AC-15)	—	0.7A	0.5A
			DC	Resistive Load (DC-12)	1A	0.2A	—
				Inductive Load (DC-13)	0.7A	0.1A	—
		Monitor Switch (NC contact) (Terminal No. 31-32/A2-B2)	AC	Resistive Load (AC-12)	—	2.5A	1.5A
				Inductive Load (AC-15)	—	1.5A	0.75A
			DC	Resistive Load (DC-12)	2.5A	1.1A	0.55A
				Inductive Load (DC-13)	2.3A	0.55A	0.27A
	Control Unit	Emergency Stop Switch XA1E-BV3U02R (Terminal No.1-2/A1-B1, 1-2/A2-B2)	AC	Resistive Load (AC-12)	—	5A	3A
				Inductive Load (AC-15)	—	3A	1.5A
			DC	Resistive Load (DC-12)	2A	0.4A	0.2A
				Inductive Load (DC-13)	1A	0.22A	0.1A
		Momentary Pushbutton Key Selector Switch AB6M-M2PLW, AS6M-2KT2PA (Terminal No.C1/B1, N01/B2, NC1/B3, C2/A1, N02/A2, NC2/A3)	AC	Resistive Load (AC-12)	—	0.5A	—
				Inductive Load (AC-15)	—	0.3A	—
			DC	Resistive Load (DC-12)	1A	0.2A	—
				Inductive Load (DC-13)	0.7A	0.1A	—
UP9 Pilot Light UP9P-2498G (Terminal No. +, -)				Rated operating voltage: 24V DC ±10% Rated current: 15mA			

Overview

XW Series E-Stops

Interlock Switches

Enabling Switches

Safety Control Relays

Light Curtains

AS-Interface Safety at Work

 Note: Minimum applicable load (reference value): 3V AC/DC, 5 mA (Applicable range is subject to the operating conditions and load.)
 *Operating temperature for internal connectors:
 -25°C min., 40°C max. 2.5A (12 to 19 poles), 2A (20 to 22 poles)
 40°C min., 50°C max. 2.5A (8 to 12 poles), 2A (13 to 22 poles)
 50°C min., 60°C max. 2.5A (6, 7 poles), 2A (8 to 13 poles), 1.5A (14 to 22 poles)

Operation Characteristics

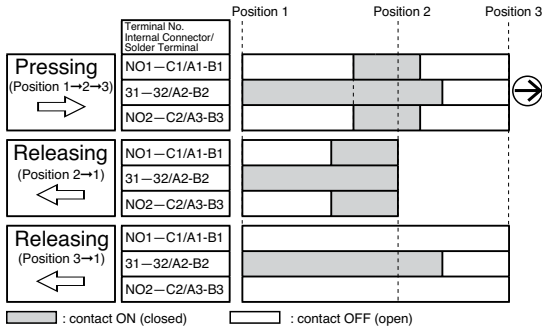

 Terminals NO1-C1/A1-B1, NO2-C2/A3-B3 are outputs of the 3-position enabling switch.
 The above operation characteristics show when the center of the grip switch button is pressed. Because two contacts are designed to operate independently, pressing the edge of the button turns on one contact earlier than the other contact, causing a delay in operation. To avoid this, always press the center of the button.

Dimensions (mm)
HE2G-21SH/HE2G-21SC

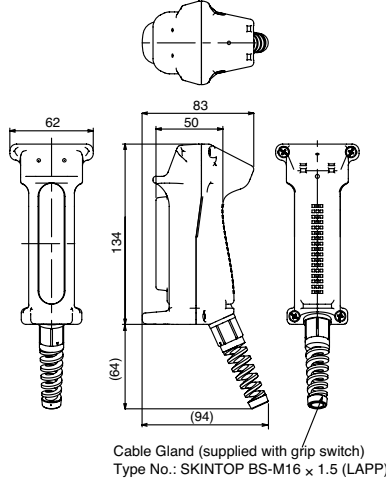

All dimensions in mm.

Internal Connector

Cable side connector:

Tyco Electronics D-1200D Series

- Receptacle: 1-1827864-□
- Receptacle contact
 1827586-2: AWG28 to 30 (Hand tool: 1762952-1)
 1827587-2: AWG22 to 28 (Hand tool: 1762846-1)
 1827588-2: AWG22 to 28 (Hand tool: 1762950-1)
 1827589-2: AWG18 to 22 (Hand tool: 1762625-1)

Specify 2 or 3 in place of □.

- 2: 4-pin connector
- 3: 6-pin connector

The customer needs to purchase the connector separately.

Additional Control Unit Layout

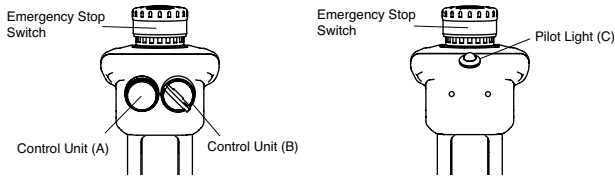

Contact Arrangement (Internal Connector)

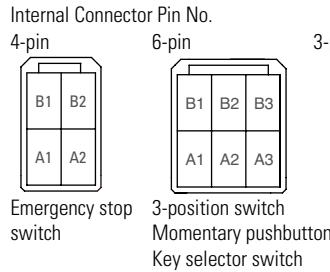

3-position switch /control unit side connector:

Tyco Electronics D-1200D Series

Tab housing: 1-1903130-2 (4-pin connector)

1-1903130-3 (6-pin connector)

Tab contact: 19303116-2

Terminal Arrangement (TOP VIEW) 6-Pin Connector Allotment Table

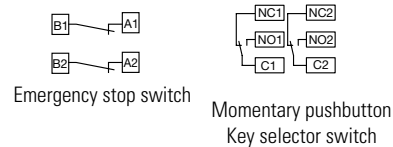

Internal Connector Pin No.	Momentary pushbutton Key selector switch
A1	C2
A2	NO2
A3	NC2
B1	C1
B2	NO1
B3	NC1